

Product specification

1. GENERAL SPECIFICATIONS

1-1 SCOPE:

This specification covers the delivery requirements for the liquid crystal display delivered by to Customer.

1-2 PRODUCTS:

Liquid Crystal Display Module (LCM)

2. FEATURES

ITEM	SPECIFICATIONS
Part No.	LB04301
SIZE	4.3 "TFT
Display Type	16.7M TFT, Transmissive
Viewing Direction	12 O' clock
Driving IC	OTA5180A
Backlight	10-Chip WHITE LED
Operating Temperature	-20°C ~+70°C
Storage Temperature	-30°C ~+80°C

3. MECHANICAL SPECIFICATIONS

ITEM	SPECIFICATIONS	UNIT
OUTLINE DIMENSIONS	105.50 (W) x 67.20 (H) x 2.60 (T)	mm
ACTIVE AREA	95.04 (W) x 53.86 (H)	mm
NUMBER OF DOTS	480RGB x 272 Dots	----
ASSY. TYPE	COG+FPC+BL	----
WEIGHT	TBD	g

Product specification

5. INTERFACE ASSIGNMENT

NO.	Symbol	Description
1	VLED-	B/L PIN
2	VLED+	B/L PIN
3	GND	Ground
4	VDD	Power supply(3.3V)
5-12	R0-R7	Data Bus(R0-R7)
13-20	G0-G7	Data Bus(G0-G7)
21-28	B0-B7	Data Bus(B0-B7)
29	GND	Ground
30	PCLK	Dot-clock signal and oscillator source
31	DISP	Display on/off
32	HSYNC	Line synchronization signal
33	VSynd	Frame synchronization signal
34	DE	Display enable pin from controller
35	NC	Not Connect
36	GND	Ground
37	XR	Touch pad for x_right
38	YD	Touch pad for y_down
39	XL	Touch pad for x_left
40	YU	Touch pad for y_up

Product specification

6. TIMING/CHARACTERISTICS

9.4.1 Clock and Data Input Timing Diagram

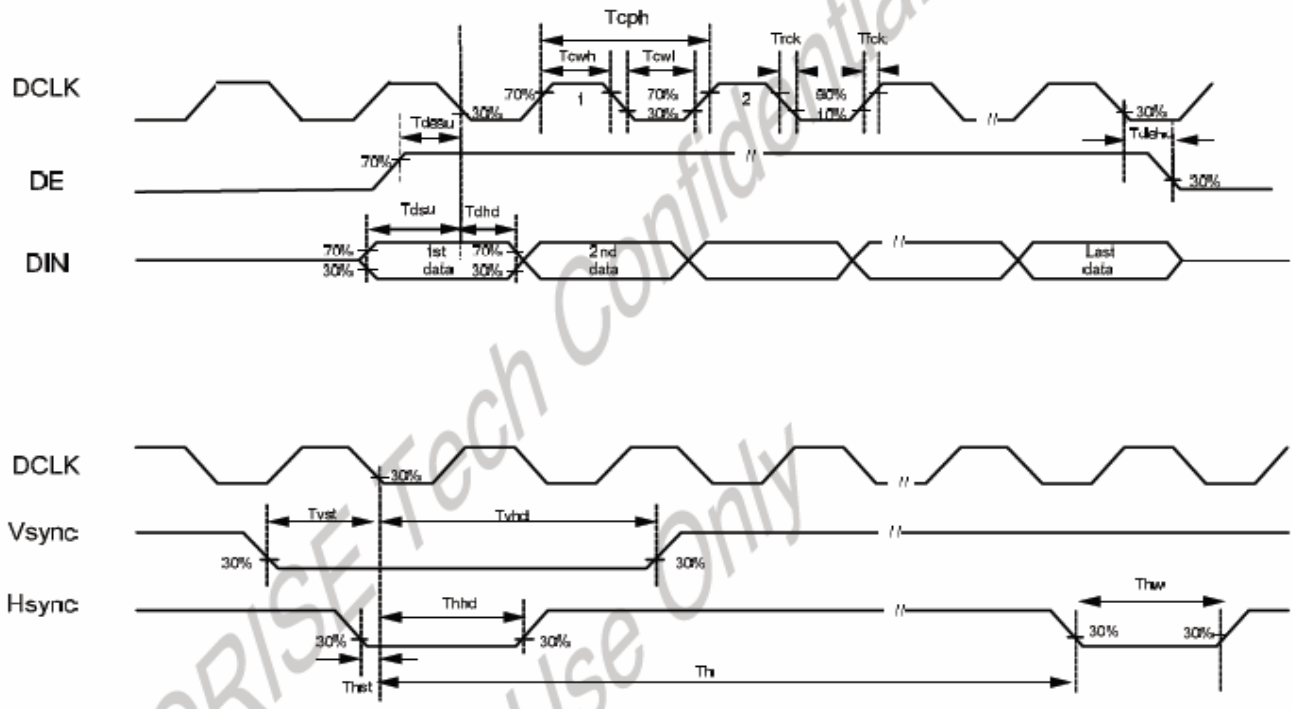

10.1.1 Parallel RGB Input Timing Table

Item	Symbol	Min.	Typ.	Max.	Unit		
DCLK Frequency	Fclk	5	9	12	MHz		
DCLK Period	Tclk	83	110	200	ns		
Hsync	Period Time	Th	490	531	605	DCLK	
	Display Period	Thdisp		480		DCLK	
	Back Porch	Thbp	8	43		DCLK	By H_BLANKING setting
	Front Porch	Thfp	2	8		DCLK	
	Pulse Width	Thw	1			DCLK	
Vsync	Period Time	Tv	275	288	335	H	
	Display Period	Tvdisp		272		H	
	Back Porch	Tvbp	2	12		H	By V_BLANKING setting
	Front Porch	Tvfp	1	4		H	
	Pulse Width	Tvw	1	10		H	

Product specification

10.1.3 SYNC-DE Mode Timing Diagram

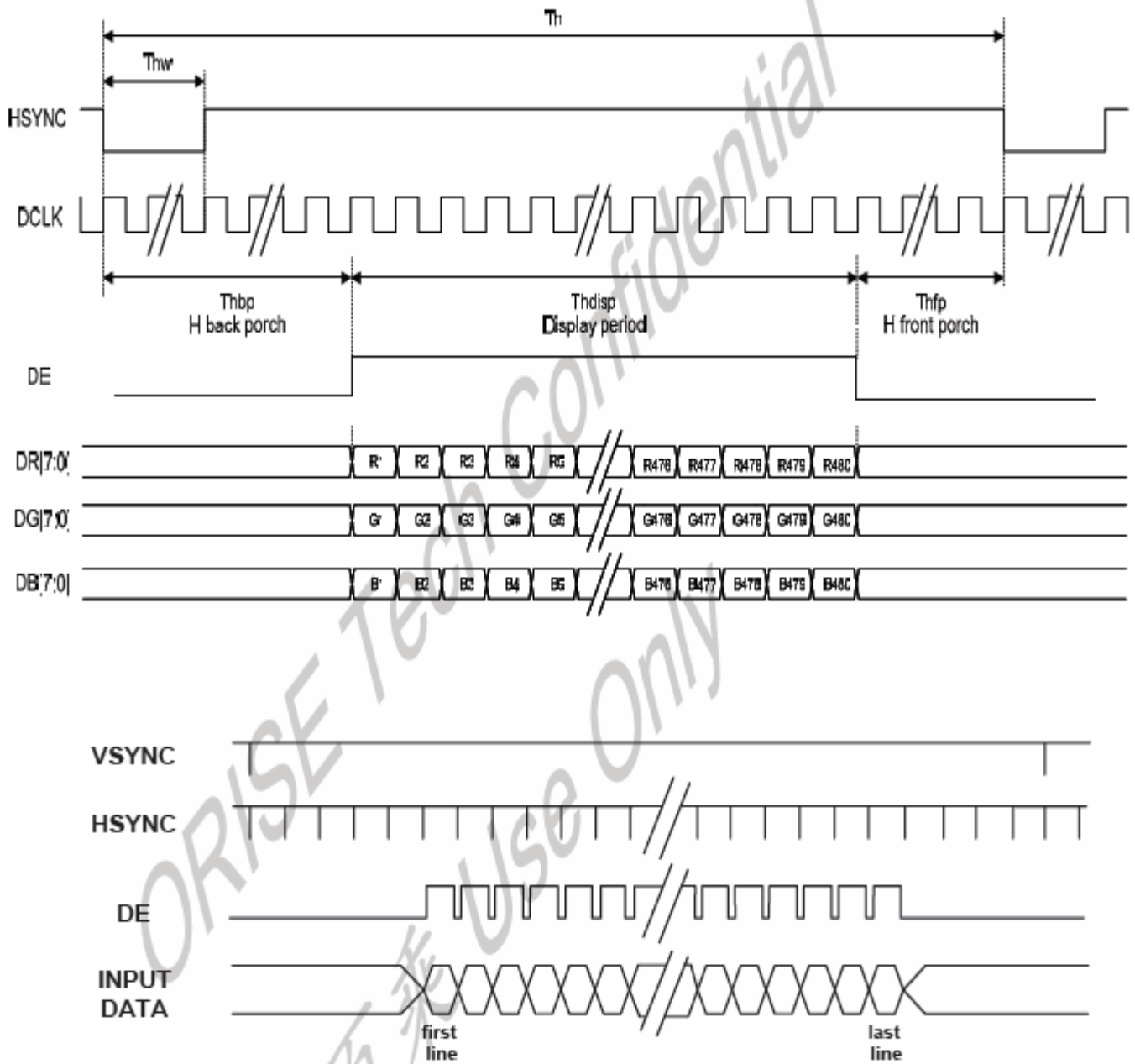

Product specification

7. POWER ON/OFF SEQUENCE

11.1.1 Power On Sequence

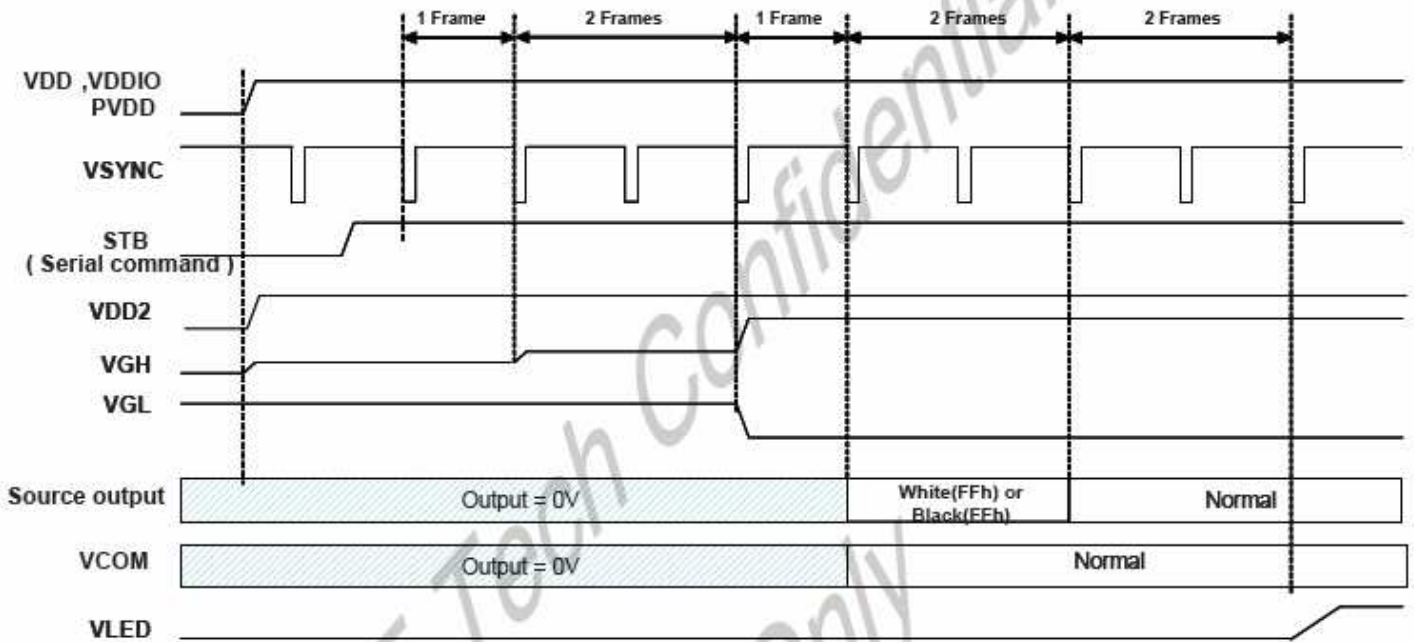

11.1.2 Power On Sequence

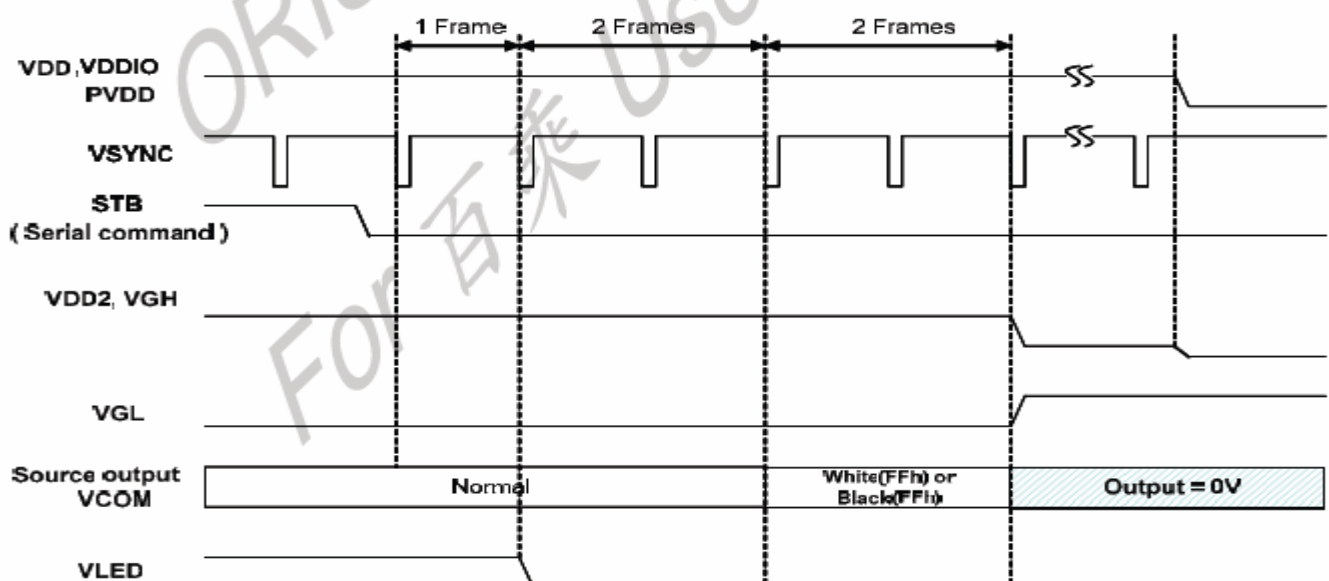

Note:

- a. When normally-black LC is used, please send black pattern to discharge the panel.
- b. When normally-white LC is applied, please send white pattern to discharge the panel.

Product specification

8. ELECTRICAL CHARACTERISTICS

PARAMETER	SPECIFICATIONS	TYP
Logic supply voltage VDD	-0.5V TO +5V	3.3 V
Analog supply voltage VDDA	-0.5V TO +7.5V V	5.0 V
VGH	+9v to +16v	+15V
VGL	-9v to -11v	-10V

9. LED BACKLIGHT

9-1 POWER SUPPLY FOR LED BACKLIGHT



9-2 ELECTRICAL CHARACTERISTICS

PARAMETER	SYMBOL	lamp	REMARK	STANDARD VALUE		
				MIN	TYP	MAX
FORWARD VOLTAGE	V _f	WHITE		----	16V	----
LUMINOUS INTENSITY (complete module)	I _v	WHITE		I _f = <u>40</u> MA	270 cd/m ²	280 cd/m ²
LUMINOUS TOLERANCE	I _{v-m}	WHITE	(min/max)/100	80	----	----

Product specification

10. OPTICAL CHARACTERISTICS

ITEM	SYMBOL	CONDITION	MIN.	TYP.	MAX.	UNIT	REMARK			
Transmittance	T		6.0	6.4		%	Note 2			
Contrast Ratio	CR	*1)	250	350	--	--	Note 3			
Response Time	Tr+ Tf	*3)	-	30	45	ms	Note 4			
Viewing Angle	Vertical	$\theta^{*2)}$	$CR \geq 10$	90	110	--	Note 5			
						--				
	Horizontal					$\psi^{*2)}$		110	130	--
										--
Color Filter Chromacity with C light	White	x y	$\theta = \phi = 0^\circ$	0.287	0.307	0.327	Note 6			
				0.325	0.345	0.365				
	Red	x y	$\theta = \phi = 0^\circ$	0.589	0.609	0.629				
				0.297	0.317	0.337				
	Green	x y	$\theta = \phi = 0^\circ$	0.297	0.317	0.337				
				0.523	0.543	0.563				
	Blue	x y	$\theta = \phi = 0^\circ$	0.117	0.137	0.157				
				0.141	0.161	0.181				
	NTSC			-	48.1%	-				

Note 1. Ambient condition : $25^\circ\text{C} \pm 2^\circ\text{C}$, $60 \pm 10\% \text{RH}$, under 10 Lux in the darkroom .

Note 2. Measure device : BM-5A (TOPCON) , viewing cone= 1° , $I_L=20\text{mA}$.

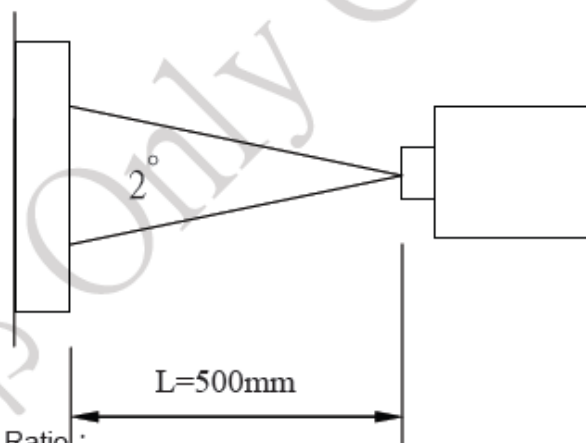

Note 3. Definition of Contrast Ratio :

$$CR = \text{White Luminance (ON)} / \text{Black Luminance (OFF)}$$

Product specification

Note 4. Definition of response time : The response time is defined as the time interval between the 10% and 90% amplitudes.

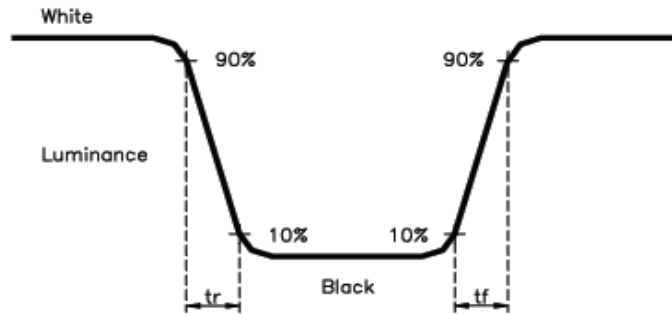

Note 5. Definition of view angle(θ , ψ) :

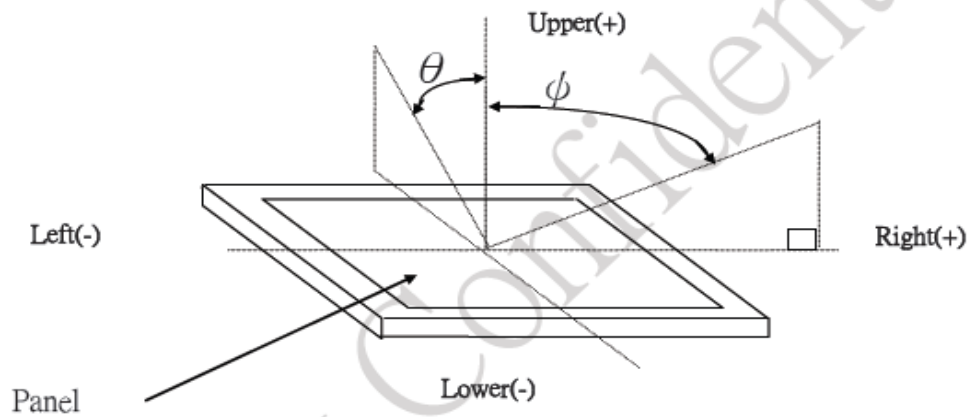

Note 6. Light source: C light.

Product specification

11. ENVIRONMENTAL ABSOLUTE MAXIMUM RATINGS

ITEM	SYMBO	CONDITIONS	CRITERION
OPERATING TEMPERATURE	TOPR	-20°C ~+70°C	NO DEFECT IN DISPLAYING AND OPERATIONAL FUNCTION
STORAGE TEMPERATURE	TSTG	-30°C ~+80°C	NO DEFECT IN DISPLAYING AND OPERATIONAL FUNCTION
HUMIDITY	—	See Note	WITHOUT CONDENSATION

NOTE: TEST CONDITION

- (1) Temperature and humidity: If no specification, temp .set at $25 \pm 2^\circ\text{C}$.humidity
- (2) Operating state: Samples subject to the test shall bein “operating”condition

12. RELIABILITY TEST

ITEM	CONDITIONS	CRITERION
OPERATING TEMPERATURE	HIGH TEMPERTURE +50°C 72HRS	NO DEFECT IN DISPLAYING AND OPERATIONAL FUNCTION
	LOW TEMPERTURE -10°C 72HRS	
STORAGE TEMPERATURE	HIGH TEMPERTURE +70°C 120HRS	NO DEFECT IN DISPLAYING AND OPERATIONAL FUNCTION
	LOW TEMPERTURE - 20°C 120HRS	
HUMIDITY	40°C 90%RH 72HRS	NO DEFECT IN DISPLAYING AND OPERATIONAL FUNCTION
VIBRATION	• Operating Time: thirty minutes exposure for	NO DEFECT IN DISPLAYING AND OPERATIONAL FUNCTION
	• each direction (X, Y, Z)	
	• Sweep Frequency: 10~55Hz (1 min)	
	• Amplitude: 1.5mm	
THERMAL SHOCK	-10°C (30mins) ←5°C (5mins) →+50°C (30mins) 10 cycles	NO DEFECT IN DISPLAYING AND OPERATIONAL FUNCTION

NOTE: The samples must be free from defect before test, must be restore at room condition at least for 2 hour after reliability test before any inspection.

13. USING LCD MODULES

13-1 LIQUID CRYSTAL DISPLAY MODULES

LCD is composed of glass and polarizer. Pay attention to the following items when handling.

- (1) Please keep the temperature within specified range for use and storage. Polarization degradation, bubble generation or polarizer peel-off may occur with high temperature and high humidity.
- (2) Do not touch, push or rub the exposed polarizers with anything harder than an HB pencil lead (glass, tweezers, etc.).
- (3) N-hexane is recommended for cleaning the adhesives used to attach front/rear polarizers and reflectors made of organic substances which will be damaged by chemicals such as acetone, toluene, ethanol and isopropylalcohol.

Product specification

- (4) If the display surface becomes contaminated, breathe on the surface and gently wipe it with a soft dry cloth. If it is heavily contaminated, wipe gently with absorbent cotton or other soft material like chamois soaked in Isopropyl alcohol or Ethyl alcohol. Do not scrub hard to avoid damaging the display surface.
- (5) Wipe off saliva or water drops immediately, contact with water over a long period of time may cause deformation or color fading.
- (6) Avoid contacting oil and fats.
- (7) Condensation on the surface and contact with terminals due to cold will damage, stain or dirty the polarizers. After products are tested at low temperature they must be warmed up in a container before coming in contact with room temperature air.
- (8) Do not put or attach anything on the display area to avoid leaving marks on.
- (9) Do not touch the display with bare hands. This will stain the display area and degrade insulation between terminals (some cosmetics are determined to the polarizers).
- (10) Exercise care to minimize corrosion of the electrode. Corrosion of the electrodes is accelerated by water droplets, moisture condensation or a current flow in a high-humidity environment.
- (11) As glass is fragile. It tends to become or chipped during handling especially on the edges. Please avoid dropping or jarring.

13-2 PRECAUTION FOR HANDING LCD MODULES

Since LCM has been assembled and adjusted with a high degree of precision, avoid applying excessive shocks to the module or making any alterations or modifications to it.

- (1) Do not alter, modify or change the the shape of the tab on the metal frame.
- (2) Do not make extra holes on the printed circuit board, modify its shape or change the positions of components to be attached.
- (3) Do not damage or modify the pattern writing on the printed circuit board.
- (4) Absolutely do not modify the zebra rubber strip (conductive rubber) or heat seal connector.
- (5) Except for soldering the interface, do not make any alterations or modifications with a soldering iron.
- (6) Do not drop, bend or twist LCM. In particular, do not forcibly pull or bend the I/O cable or the backlight cable.
- (7) In order to avoid the cracking of the FPC, you should pay attention to the area of FPC where the FPC was bent .the edge of coverlay;the area of surface of Ni-Au plating,the area of soldering land,the area of through hole.

13-3 ELECTRO-STATIC DISCHARGE CONTROL

Since this module uses a CMOS LSI, the same careful attention should be paid to electrostatic discharge as for an ordinary CMOS IC.

- (1) Make certain that you are grounded when handing LCM. To minimize the performance degradation of the LCD modules resulting from destruction caused by static electricity etc., exercise care to avoid holding the following sections when handling the modules.
 - Exposed area of the printed circuit board.
 - Terminal electrode sections.
- (2) Before remove LCM from its packing case or incorporating it into a set, be sure the module and your body have the same

Product specification

electric potential.

- (3) When soldering the terminal of LCM, make certain the AC power source for the soldering iron does not leak.
- (4) When using an electric screwdriver to attach LCM, the screwdriver should be of ground potential to minimize as much as possible any transmission of electromagnetic waves produced sparks coming from the commutator of the motor.
- (5) As far as possible make the electric potential of your work clothes and that of the work bench the ground potential.
- (6) To reduce the generation of static electricity be careful that the air in the work is not too dried. A relative humidity of 50%-60% is recommended.

13-4 PRECAUTIONS FOR OPERATION

- (1) Viewing angle varies with the change of liquid crystal driving voltage (VO). Adjust VO to show the best contrast.
- (2) Driving the LCD in the voltage above the limit shortens its life.
- (3) If the LCD modules have been operating for a long time showing the same display patterns, the display patterns may remain on the screen as ghost images and a slight contrast irregularity may also appear. A normal operating status can be regained by suspending use for some time. It should be noted that this phenomenon does not adversely affect performance reliability.
- (4) Response time is greatly delayed at temperature below the operating temperature range. However, this does not mean the LCD will be out of the order. It will recover when it returns to the specified temperature range.
- (5) If the display area is pushed hard during operation, the display will become abnormal. However, it will return to normal if it is turned off and then back on.
- (6) Condensation on terminals can cause an electrochemical reaction disrupting the terminal circuit. Therefore, it must be used under the relative condition of 40°C , 50% RH.
- (7) When turning the power on, input each signal after the positive/negative voltage becomes stable.

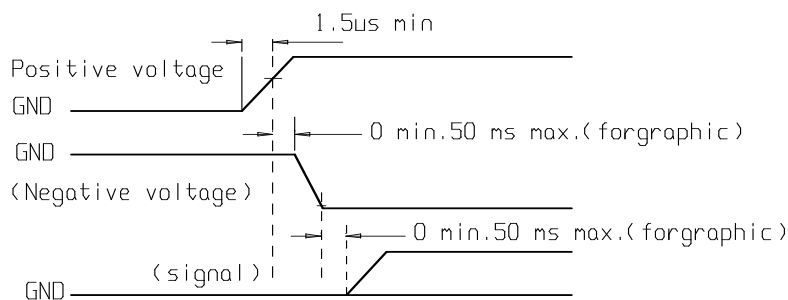

13-5 STORAGE

When storing LCDs as spares for some years, the following precaution are necessary.

- (1) Store them in a sealed polyethylene bag. If properly sealed, there is no need for dessicant.
- (2) Store them in a dark place. Do not expose to sunlight or fluorescent light, keep the temperature between 0°C and 35°C.
- (3) The polarizer surface should not come in contact with any other objects. (We advise you to store them in the container in which they were shipped.)

Product specification

(4) Environmental conditions :

- Do not leave them for more than 160hrs. at 70°C.
- Should not be left for more than 48hrs. at -20°C.

13-6 SAFETY

- (1) It is recommended to crush damaged or unnecessary LCDs into pieces and wash them off with solvents such as acetone and ethanol, which should later be burned.
- (2) If any liquid leaks out of a damaged glass cell and comes in contact with the hands, wash off thoroughly with soap and water.

13-7 LIMITED WARRANTY

Unless agreed between SUNBOND and customer, SUNBOND will replace or repair any of its LCD modules which are found to be functionally defective when inspected in accordance with SUNBOND LCD acceptance standards (copies available upon request) for a period of one year from date of shipments. Cosmetic/visual defects must be returned to SUNBOND within 90 days of shipment. Confirmation of such date shall be based on freight documents. The warranty liability of SUNBOND limited to repair and/or replacement on the terms set forth above. SUNBOND will not be responsible for any subsequent or consequential events.

13-8 RETURN LCM UNDER WARRANTY

No warranty can be granted if the precautions stated above have been disregarded. The typical examples of violations are :

- Broken LCD glass.
- Circuit modified in any way, including addition of components.

Module repairs will be invoiced to the customer upon mutual agreement. Modules must be returned with sufficient description of the failures or defects. Any connectors or cable installed by the customer must be removed completely without damaging the PCB's eyelet, conductors and terminals.

Product specification

TFT-LCM feedback information

SUNBOND Part No.		Customer' s Part No.		Sample Qty.	
Sample Version		Revision content		Sample No.	

1-1 Parameter of TFT-ICM

Item	Specs.
LCD TYPE	4.3" TFT ;12'O CLOCK 480*272dots; COG+FPC+BL ;Transmissive; Normal white
LED BACKLIGHT	10 CHIP LED 并串联（定电流=40ma）
LCD CHARACTERISTICS	VGH=15V ;VGL=-10V
DRIVER IC	OTA5180A
(VDD)	VDD=3.3v
OUTLINE DIMENSIONS (W*H*T)	105.50 mm*67.20mm*2.60mm
OPERATION/STORAGE TEMPERATURE	-20℃ ~+70℃/-30℃ ~+80℃

Prepared: windy/010-5-8

Check:

Approval:

1-2 Feedback information from customers:

Product specification

Item	Judgement	Description
Appearance	<input type="checkbox"/> OK <input type="checkbox"/> NG	
Dimension	<input type="checkbox"/> OK <input type="checkbox"/> NG	
Structure	<input type="checkbox"/> OK <input type="checkbox"/> NG	
Ability	<input type="checkbox"/> OK <input type="checkbox"/> NG	
Display effect	<input type="checkbox"/> OK <input type="checkbox"/> NG	
Opto-electrical Characteristic	<input type="checkbox"/> OK <input type="checkbox"/> NG	
Feedback information	<input type="checkbox"/> Sample is approved OK, refer to the sample for MP.	
	<input type="checkbox"/> Samples is NG, New sample is requested.	
	<input type="checkbox"/> Others	
Package	<input type="checkbox"/> Common packing.	
	<input type="checkbox"/> Special packing, please send the detail packing instruction.	
Customer' s signature & Date		

Please send back this form with your feedback information after sample testing, thanks!